

## X. SPECIFICATIONS

Model	WNX-40HW / WNX-40DS / WNX-402G / WNX-40IX
Detection method	Passive Infrared
Coverage	40ftx40ft (12mx12m) 85°
Mounting height	5ft - 8ft (1.5m - 2.4m)
Detection zones	78 zones
Sensitivity	3°F (1.6°C) at 2ft / sec (0.6m/sec)
Detectable speed	1 - 5ft/sec. (0.3 - 1.5m/sec.)
LED indicator	Switch-able ON/OFF
Tamper switch	Form C (micro switch)
Pulse Count	Approx. 20 sec   2 or 4
Battery	1 x CR123A Lithium battery
Operating temperature	-4°F - +122°F (-20°C - +50°C)
Environment humidity	85% max.

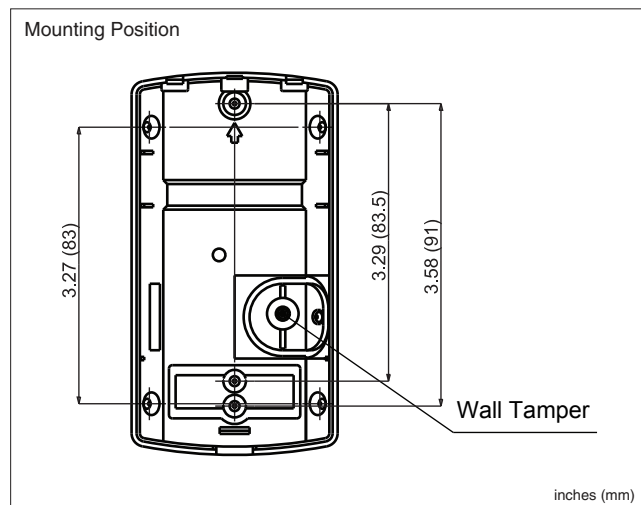
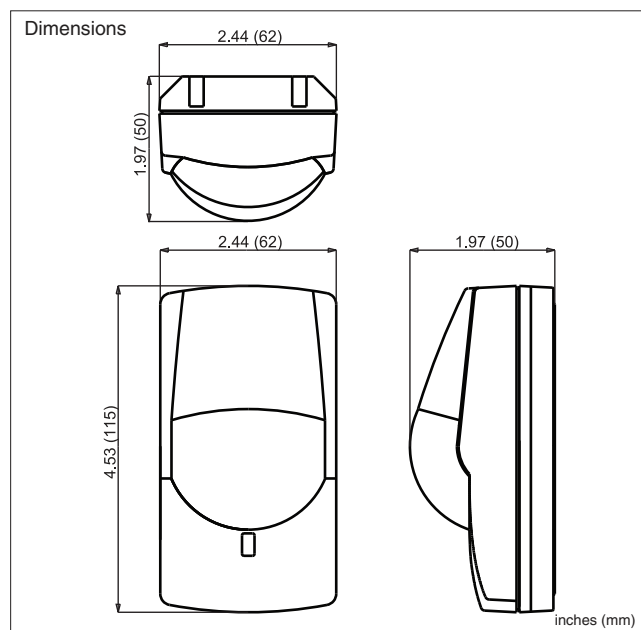

\*Specifications and design are subject to change without prior notice.

### NOTE

This unit is designed to detect an intruder and activate an alarm control panel. Being only a part of a complete system, we cannot accept responsibility for any damages or other consequences resulting from an intrusion.

### FCC ID

WNX-40HW/WNX-402G: U5X-RE261  
 WNX-40DS: U5X-RE361  
 WNX-40IX: U5X-RE161

### IC ID

WNX-40HW/WNX-402G: 8310A-RE261  
 WNX-40DS: 8310A-RE361  
 WNX-40IX: 8310A-RE161

Install in accordance with the Standard for Installation and Classification of Burglar and Holdup Alarm Systems, UL 681.

### FCC NOTICE

This device complies with Part 15 of the FCC rules. Operation is subject to the following two conditions: (1) This device may not cause harmful interference. (2) This device must accept any interference that may be received, including interference that may cause undesired operation. Changes or modifications not expressly approved by the Resolution Products, Inc. could void the user's authority to operate this equipment.

### IC NOTICE

This device complies with Industry Canada license-exempt RSS standard(s). Operation is subject to the following two conditions:

- (1) This device may not cause interference, and (2) This device must accept any interference, including interference that may cause undesired operation of the device.  
 Le présent appareil est conforme aux cnr d'Industrie Canada applicables aux appareils radio exempts de licence. L'exploitation est autorisée aux deux conditions suivantes:  
 (1) L'appareil ne doit pas produire de brouillage, et (2) L'utilisateur de l'appareil doit accepter tout brouillage radioélectrique subi, même si le brouillage est susceptible d'en compromettre le fonctionnement.

"Honeywell", "2GIG", "Interlogix", "DSC" are trademarks owned by Honeywell International, Inc, Nortek Security & Control LLC, United Technologies Corporation, and Tyco Safety Products Canada LTD, respectively. OPTEX Inc. products will function with one of either Honeywell, 2GIG, Interlogix, or DSC systems. However, no OPTEX Inc. product is produced by, endorsed by, nor is officially associated with Honeywell, 2GIG, Interlogix, DSC. OPTEX Inc. recommends verifying proper enrollment and operation, per control panel installation instructions, at installation.



OPTEX CO., LTD.(JAPAN)

URL: <http://www.optex.net>

OPTEX INC. (U.S.)

URL: <http://www.optexamerica.com>

OPTEX DO BRASIL LTDA. (Brazil)

URL: <http://www.optex.net/br/es/sec>

OPTEX (EUROPE) LTD. / EMEA HQ (U.K.)

URL: <http://www.optex-europe.com>

OPTEX TECHNOLOGIES B.V. (The Netherlands)

URL: <http://www.optex.eu>

OPTEX SECURITY SAS (France)

URL: <http://www.optex-security.com>

OPTEX SECURITY Sp.z o.o. (Poland)

URL: <http://www.optex.com.pl>

OPTEX PINNACLE INDIA, PVT., LTD. (India)

URL: <http://www.optex.net/in/en/sec>

OPTEX KOREA CO.,LTD. (Korea)

URL: <http://www.optexkorea.com>

OPTEX (DONGGUAN) CO.,LTD. SHANGHAI OFFICE (China)

URL: <http://www.optexchina.com>

OPTEX (Thailand) CO., LTD. (Thailand)

URL: <http://www.optex.net/th/th>

Copyright (C) 2016 OPTEX CO.,LTD.



2/28/2018  
59-2712-0

## INSTALLATION INSTRUCTIONS

### PASSIVE INFRARED DETECTOR

WNX-40HW/WNX-40DS  
 WNX-402G/WNX-40IX

### FEATURES

- PIR Detector
- Small animal tolerance applies to animals 0 to 40cm/0 to 16 inches in height
- Tamper switch
- Selectable pulse count 2 or 4

WNX-40HW	Honeywell 5800 Series Compatible
WNX-40DS	DSC 433MHz Compatible
WNX-402G	2GIG Compatible
WNX-40IX	Interlogix 319.5MHz & QOLSYS Compatible

\*Product is not produced by, endorsed by, nor is officially associated with Honeywell, DSC, 2GIG, Interlogix, or QOLSYS.

### I. INSTALLATION HINTS

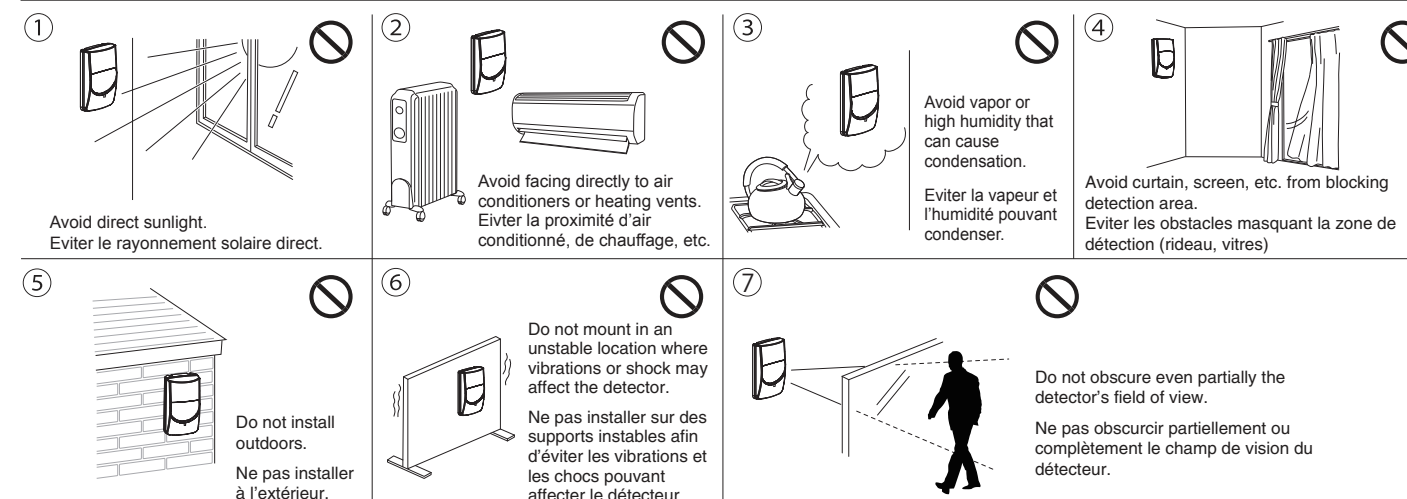

The sign indicates prohibition. Le signe indique une interdiction.

### II. DETECTION AREA

#### TOP VIEW

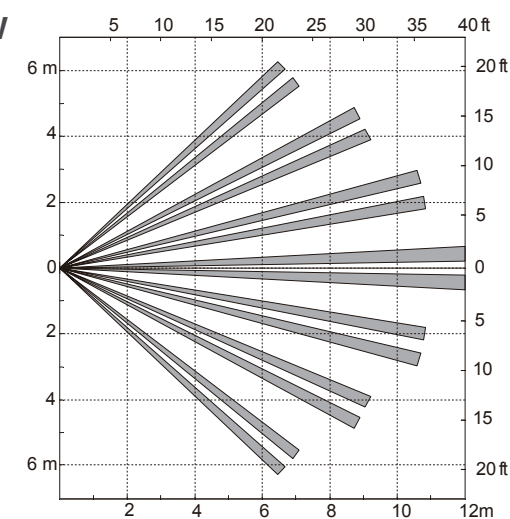

#### SIDE VIEW

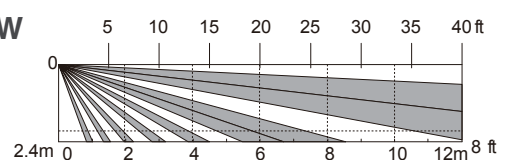

### III. DESCRIPTION AND OPERATION

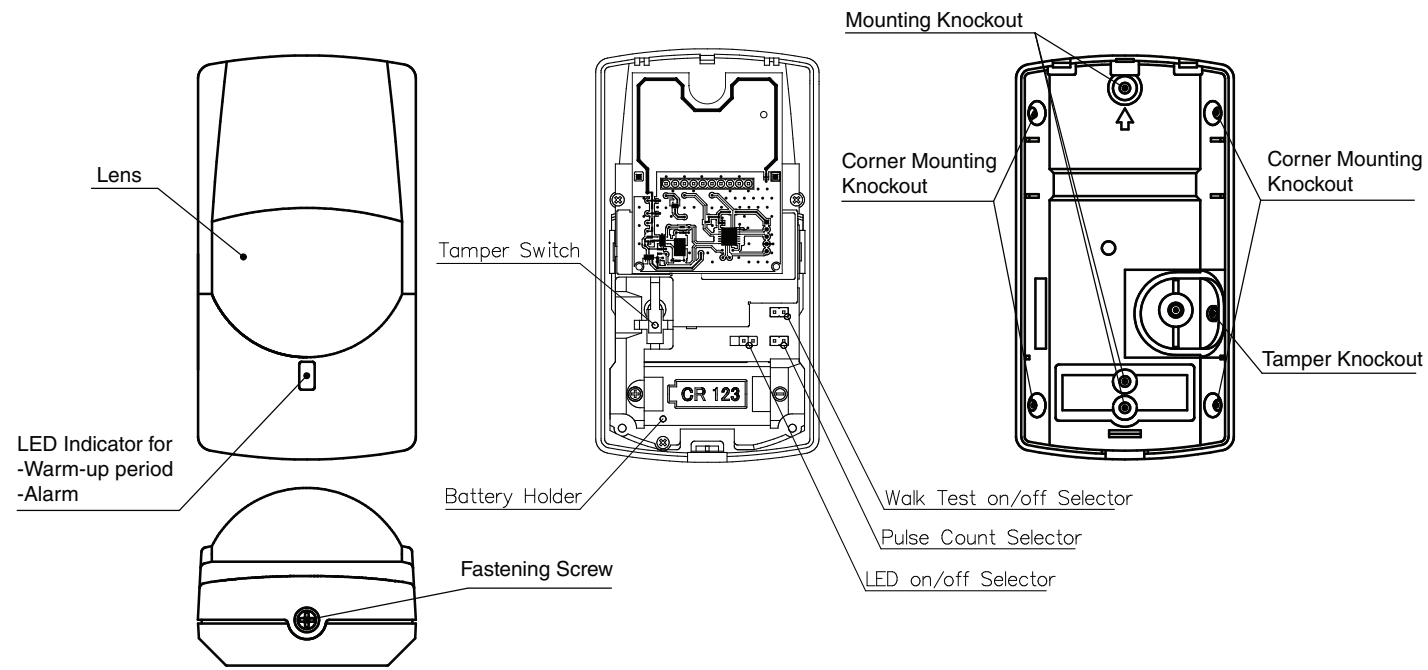

### IV. MOUNTING

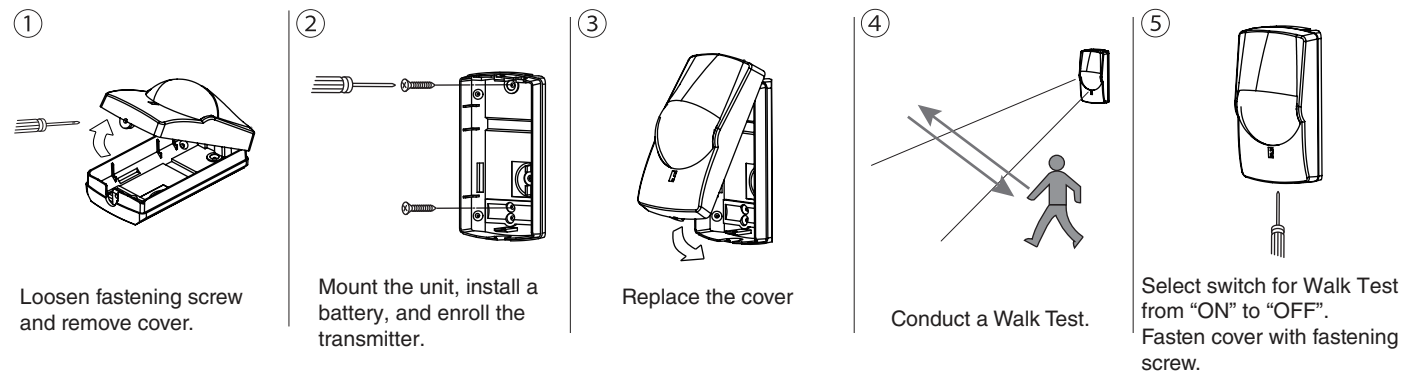

### V. ENROLLING TO CONTROL PANEL

#### Interlogix:

##### Programming/Enrolling

- Place control panel into enrollment mode
- Remove battery tab to automatically send entire RF enrollment sequence, or
- Open cover to send Tamper Signal

#### QOLSYS:

##### Programming/Enrolling

- Place control panel into enrollment mode.
- Remove battery tab to automatically send entire RF enrollment sequence, or
- Open cover to send Tamper Signal

#### Honeywell:

##### Programming/Enrolling

- Enroll by placing the panel into wireless enrollment mode
- Remove battery tab while holding Tamper to automatically send entire RF enrollment sequence, or
- Trip (alarm or tamper) 3 times, or
- Enter the sensors ID number

##### Enrollment Tips

- Program as an RF type (Supervised RF)
- Program as Loop 1
- Loop 4 = Tamper

#### 2GIG:

##### Programming/Enrolling

- Place control panel into enrollment mode
- Remove battery tab while holding tamper to automatically send entire RF enrollment sequence, or
- Trip (alarm or tamper) 3 times, or
- Enter the sensors ID number

##### Enrollment Tips

- Confirm Loop 1 is selected
- Power down the PIR after enrollment to keep panel from mistakenly double enrolling the sensor.

#### DSC:

##### Programming/Enrolling

- Place control panel into enrollment mode
- Remove battery tab to automatically send entire RF enrollment sequence, or
- Open cover to send Tamper Signal, or
- Enter the sensors ID number

#### Cryptix:

##### Programming/Enrolling

- Place control panel into enrollment mode
- Remove battery tab to automatically send entire RF enrollment sequence, or
- Open cover to send Tamper Signal, or
- Enter the sensors ID number

### VI. FUNCTIONS

#### 1. LED ON / OFF

The Alarm LED indicator can be switched either "ON" or "OFF".

#### 2. PULSE COUNT

The Detection Mode can be switched to either "2" or "4" depending on the environmental conditions of installation.

2: For normal applications.

4: For use in hostile areas where there may be movement of small animals or other objects such as fax machines or curtains.

When the "4" is selected, the sensitivity may seem sluggish. Conduct a Walk Test to ensure that the desired coverage is given.

#### 3. WALK TEST SWITCH

##### WALK TEST

- 1) LED lights up when the unit has detected.
- 2) An alarm signal is output whenever it detects.

##### NORMAL : Normal Operation (Battery Saving Mode)

- 1) LED lights up when unit detects and "LED ON" is selected.
- 2) Once alarm is generated, another alarm will not generate for 2 minutes.

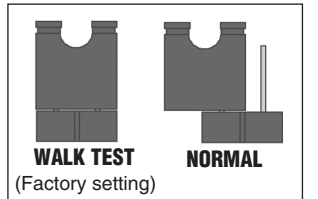
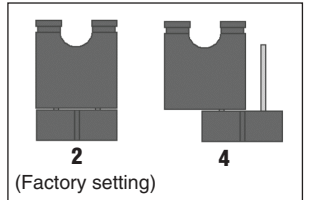
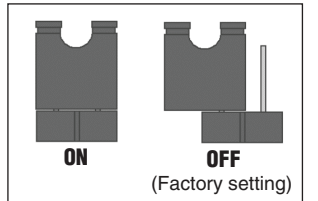

### VII. TROUBLE SHOOTING AND MAINTENANCE

PROBLEM	PROBABLE CAUSE	REMEDY
Alarm is not activated although someone is walking in detection area.	Detection area is improper.	Conduct a walktest. See Section II.
	Battery is dead.	Change battery.
	Walk Test switch is OFF.	Turn the Walk Test switch on. See Section VI.
Unintended activation (False Alarm)	Moving object within detection area. (curtain, wall hanging, etc.)	Remove the object from the detection area.
	Temperature of object within area is changing rapidly. (heater, air conditioning, etc.)	Remove the heat sources from the detection area or relocate the detector.
LED does not light up at the time of walk test.	Walk Test switch is OFF.	Turn the Walk Test switch on.
	Battery is dead.	Change battery.

\*Conduct a walk test at least once per year.

### VIII. BATTERY LIFE

The values indicated are only for reference on each condition. The sensor will send low battery transmissions to the control panel.

CR123A (3V, 1300mAh)

Alarm trigger per day	Battery Life
240	Approx. 7 years
720	Approx. 3 years

### IX. OPTIONAL ACCESSORIES

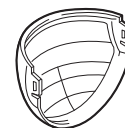

**LONG RANGE**  
(OPTIONAL LENS: FL-60N)  
18 x 1.8m (60 x 6ft.)

#### HOW TO REMOVE & FIT LENS

To remove, press both lens hooks to outside and push to the front.  
To fit, press the lens into cover from the front.

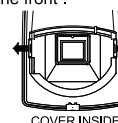

COVER INSIDE

#### TOP VIEW

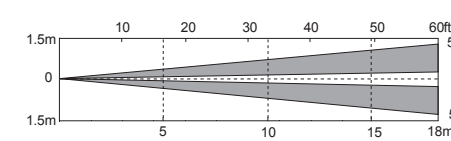

#### SIDE VIEW

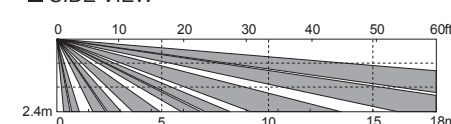

#### FA-3 Compact Wall & Ceiling Mount Bracket

