

# 6280 TouchCenter Keypads

## Installation Guide



For Online Support visit: <http://www.security.honeywell.com/hsc/resources/MyWebTech/>

### General Information

This guide provides information on installing and setting up Honeywell's 6280 TouchCenter™ Keypads. The 6280 Series graphical touch-screen keypads are Advanced User Interface (AUI) devices, which combine control of your security system, multi-media and premises lighting.

**Software Information:** To check the latest software information, press the Setup and System Info icons; the latest Software Version is displayed.

**Compatibility:** For a list of alarm systems that the TouchCenter can interface with, refer to the Compatibility Table in this document.

#### Wiring

**IMPORTANT:** If you power the TouchCenter from your panel's auxiliary power output, check your panel's Installation and Setup Guide and verify that this device and others do not exceed your panel's auxiliary power output capability; if it does, a supplementary power supply is needed.

#### Word List

The 6280 TouchCenter can announce a series of words. You must use the vocabulary list in your alarm panel instructions for actual words that may be announced.

### 6280 TouchCenter

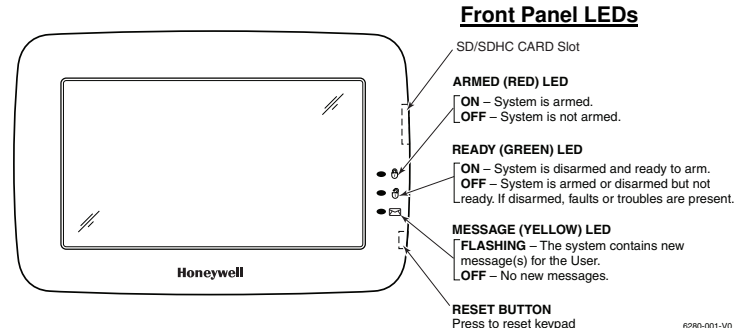

### Mounting the TouchCenter

This Keypad is for indoor use only and should be mounted at a comfortable viewing level. Avoid mounting in areas of high condensation such as bathrooms or in locations where bright light or sunlight shines directly on the screen. The TouchCenter can be mounted with or without the mounting plate. Use the center securing screw for European installation.

#### Standard Mounting with mounting plate:

1. Select a mounting location.
2. Detach the mounting plate by sliding downward.
3. Use the mounting plate to mark the location of the mounting holes on the mounting surface and check for level.
4. Locate the mounting plate over the mounting surface such that the wire/cable access openings are aligned while passing the wires/cable through the case back.
- \*\*\*Go to "Wiring the TouchCenter" and complete wiring\*\*\*
5. Secure the mounting plate to mounting surface using 4 screws (supplied).
6. Slide TouchCenter onto mounting plate.

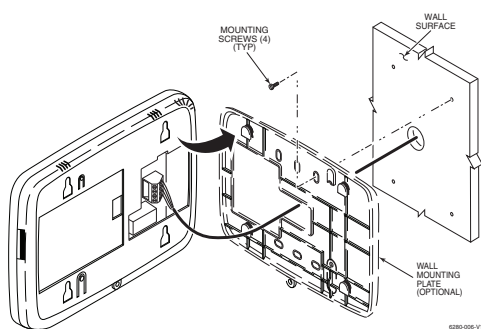

#### Mounting without mounting plate:

1. Select a mounting location.
2. Detach the mounting plate by sliding downward and discard.
3. Use the template (provided in the carton) to mark the location of the mounting screws and the cut-out for the TouchCenter assembly on the mounting location. Check for level.
4. Install 4 screws (supplied) in the mounting surface leaving screw heads 1/8" above the mounting surface.
5. Locate the case back over the mounting surface such that the opening is aligned with the wire/cable access opening on the mounting surface while passing the wires/cable through the opening in the case back.
- \*\*\*Go to "Wiring the TouchCenter" and complete wiring\*\*\*
6. Mount TouchCenter by sliding onto the screw heads.

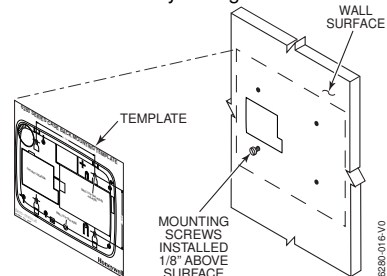

The 6280 complies with the European Standard EN50131 and is designed to prevent unauthorized use.

#### Mounting (European Installations) using a center securing screw:

1. Detach case front by removing the two bottom screws. Gently pull up using a screwdriver if necessary and pry apart. Lift off cover.
  2. Mount the TouchCenter in its final location, (see "Standard Mounting" or "Mounting without the mounting plate") install center securing screw (supplied) and tighten to mounting surface.
  3. Replace the case front and secure using the two bottom screws.
- Note:** The European mounting procedure has not been evaluated by UL.

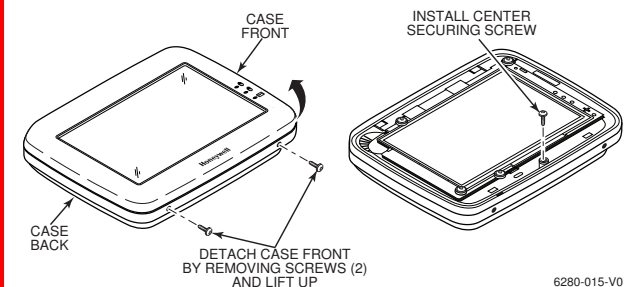

### Wiring the TouchCenter

Mechanical Specifications:			
Width:	8.23 inches (209.04mm)		
Height:	5.59 inches (141.99mm)		
Depth:	1.13 inches (28.70mm)		
Electrical Specifications:			
Backlight OFF, Sound OFF	9.6VDC	12VDC	13.8VDC
Backlight ON, Sound OFF	170mA	140mA	125mA
Backlight ON, Sound ON	270mA	215mA	190mA
Backlight ON, Sound ON	325mA	255mA	230mA
Operating Environment:			
Humidity	93% RH, non-condensing		
Temperature:			
Operating:	14° F to 131° F / -10° C to 55° C (UL tested 32°-120° F / 0 to 49° C)		
Shipping / Storage	-40° F to 158° F / -40° C to 70° C		
Wire Gauge:			
#22 gauge	150 feet		
#20 gauge	240 feet		
#18 gauge	350 feet		
#16 gauge	550 feet		

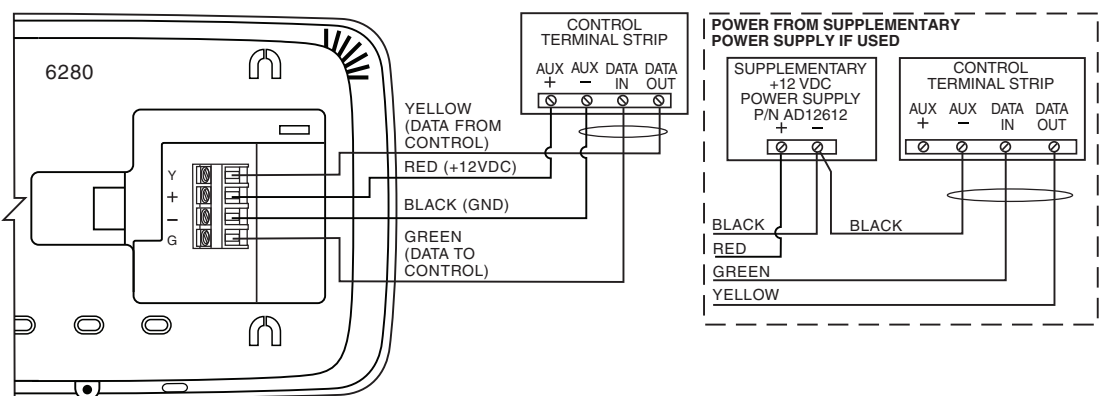

**Note:** Unshielded 4-conductor cable is recommended for the power/data wire.

**UL** Use a UL Listed, battery-backed supply for UL installations. The battery supplies power to these keypads in case of AC power loss. The battery-backed power supply should have enough power to supply the keypads with the UL required minimum standby power time.

**IMPORTANT:** Keypads powered from supplies that do not have a backup battery do not function if AC power is lost. Make sure to power at least one keypad in each partition from the control's auxiliary power output or UL Listed battery backed up power supply.

**IMPORTANT:** When the TouchCenter is powered from an auxiliary power supply, always apply power to the control panel first and then the TouchCenter. Failure to observe this sequence results in improper operation of the TouchCenter and may result in an ECP Error indication.

**Note:** Supplementary external power supply must be Listed to UL 603 for UL installations, CAN/ULC-S318 for cUL installations, and capable of providing the required backup power.

#### Connect the wires to the TouchCenter terminal block as shown.

- Connect the TouchCenter in parallel with keypads and other peripheral devices using the keypad data (ECP) bus.
- If the TouchCenter is used as the primary system keypad, maximum wire run length is 150 feet.
- If more than one keypad is wired to one run, then the maximum lengths must be divided by the number of keypads on the run. (e.g., the maximum length is 75 feet if two keypads are wired on a #22 gauge run).
- DO NOT use several hardwired motion detectors in high traffic locations.

### Initial Setup

#### Programming the Control Panel

The TouchCenter is not fully operational unless its address in the control panel has been enabled (set as an alpha console) AUI type device, and assigned to a partition (where applicable).

We recommend that you use either a standard alpha keypad or the TouchCenter in Console Emulation Mode when programming the control panel. When in the Console Mode, the TouchCenter emulates an alpha keypad and the programming of the panel is performed following the procedures provided in your panel's Installation & Setup Guide.

#### Notes:

1. DO NOT perform panel programming while in the Safe Mode.
2. When programming your control panel, if you change the zone types for your emergency zones you may disable the emergency buttons in the TouchCenter. The emergency buttons in the TouchCenter are active for zone types 06 (Silent Panic Button) and 07 (Panic Button), 08 (Medical Button), and 09 (Fire Button). Additionally, the Medical Button is also compatible with a zone type 15 (24-Hour Medical) for panels that contain this zone type.

**Note:** Medical functionality has not been evaluated by UL and may not be used in UL Listed applications.

The TouchCenter should not be assigned as a Master Console. If the TouchCenter is assigned as a Master Console, partitions must be controlled from the Partition screen or by using the Console Emulation Mode.

#### TouchCenter Initialization

When initially powered, the screen displays the boot sequence and the "Set ECP Address" screen is displayed. If the system is incorporating only one TouchCenter, leave the address set to 1 and touch **Apply**. The boot-up process continues until completion. If there are to be additional TouchCenter units in the system, after

enabling addresses in the control panel using an alpha-keypad, power-up each TouchCenter one at a time, and set its address to one of the addresses you enabled in the control panel.

**Note:** If the top of the screen is displaying ECP Error, the TouchCenter ECP Address is not valid for the panel that it is connected to. To change the ECP Address, enter the default code of "4140" to advance to the next screen.

**Note:** 4140 is the TouchCenter default installer code before connecting to a control panel. Once connected to a control panel, use the panel's installer code. Change the ECP Address on the unit, using the Up/Down arrows and then touch apply to accept the address and reset the TouchCenter. Once communication has been restored, then use the standard panel installer code for all installer functions. Refer to "ECP Setup" section.

#### Language Selection

After initial ECP selection is set, the « Languages » menu is displayed. Select from English, French Canadian and Latin American Spanish.

**Installer Note:** The 6280 Touch Screen has been calibrated at the factory. Ignore the "CALIBRATE" button that appears on the "Options" screen after initial ECP setup. If the screen should require recalibration, do so via the "Keypad Test" screen. See the "Diagnostic Tests" section for instructions.

#### Time/Date Setup







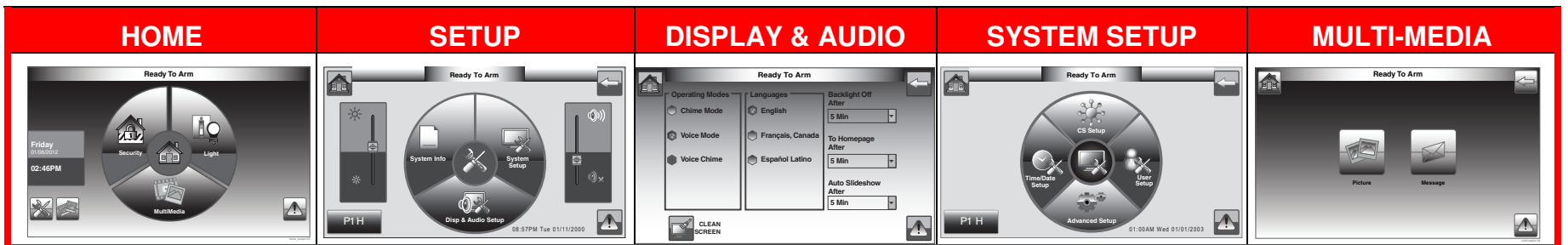





If not already set from the panel, set the current time and date. Refer to "Time/Date Setup" section.

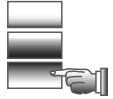













#### NIGHT Setup

The TouchCenter is defaulted to arm the system in the STAY INSTANT mode when arming the system using the NIGHT icon. Select the arming mode to be activated when the NIGHT icon is touched on the "Arming" screen, refer to "Night Setup" section.



HOME		SETUP		DISPLAY & AUDIO		SYSTEM SETUP		MULTI-MEDIA																																									
<b>Adjust the Brightness / Volume</b>				<b>Notes</b>				<b>Navigation Icons</b>																																									
<ol style="list-style-type: none"> <li>1. Touch the <b>Setup</b> icon located in the lower left corner of the "Home" screen.</li> <li>2. Move the <b>Brightness/Volume</b> slide bar to adjust the brightness/volume.</li> </ol>		<p>If changes are made, when you exit a <b>Settings Changed!</b> Pop-up window is displayed asking <b>"Remember New Settings?"</b> <b>Yes</b> saves the change. <b>No</b> discards the change.</p>				<table border="1"> <thead> <tr> <th>ICON</th> <th>ICON TITLE</th> <th>FUNCTION</th> </tr> </thead> <tbody> <tr> <td></td> <td>"Message"</td> <td>Record and retrieve Voice Messages.</td> </tr> <tr> <td></td> <td>"Light"</td> <td>Turn certain devices on and off (if installed and programmed by your installer.)</td> </tr> <tr> <td></td> <td>"Security"</td> <td>Accesses "Security" screen.</td> </tr> <tr> <td></td> <td>"Home"</td> <td>Returns you to the "Home" screen.</td> </tr> <tr> <td></td> <td>"Back"</td> <td>Reverts to the last screen viewed.</td> </tr> <tr> <td></td> <td>"Panic"</td> <td>Displays Emergency functions (as programmed by the installer). See Programming the Control Panel note. <b>Note:</b> This icon is displayed and active on all screens except while in the Clean Screen mode and during an LCD Display test in Diagnostics.</td> </tr> <tr> <td></td> <td>"Control Panel Message"</td> <td>This icon alerts the user to a Control Panel Message.</td> </tr> <tr> <td></td> <td>"Multi-Media"</td> <td>Accesses the Message and Picture features.</td> </tr> <tr> <td></td> <td>"Setup"</td> <td>Allows access to Setup menus.</td> </tr> <tr> <td></td> <td>"Voice Status"</td> <td>Allows user to hear system status.</td> </tr> <tr> <td></td> <td>"Picture"</td> <td>Allows user to display personal photos in a slide show format.</td> </tr> <tr> <td></td> <td>"Minimize Home"</td> <td>Minimizes the Home screen icons when viewing wallpaper displays.</td> </tr> <tr> <td></td> <td>"Maximize Home"</td> <td>Maximizes the Home screen icons when viewing wallpaper displays.</td> </tr> </tbody> </table>		ICON	ICON TITLE	FUNCTION		"Message"	Record and retrieve Voice Messages.		"Light"	Turn certain devices on and off (if installed and programmed by your installer.)		"Security"	Accesses "Security" screen.		"Home"	Returns you to the "Home" screen.		"Back"	Reverts to the last screen viewed.		"Panic"	Displays Emergency functions (as programmed by the installer). See Programming the Control Panel note. <b>Note:</b> This icon is displayed and active on all screens except while in the Clean Screen mode and during an LCD Display test in Diagnostics.		"Control Panel Message"	This icon alerts the user to a Control Panel Message.		"Multi-Media"	Accesses the Message and Picture features.		"Setup"	Allows access to Setup menus.		"Voice Status"	Allows user to hear system status.		"Picture"	Allows user to display personal photos in a slide show format.		"Minimize Home"	Minimizes the Home screen icons when viewing wallpaper displays.		"Maximize Home"	Maximizes the Home screen icons when viewing wallpaper displays.
ICON	ICON TITLE	FUNCTION																																															
	"Message"	Record and retrieve Voice Messages.																																															
	"Light"	Turn certain devices on and off (if installed and programmed by your installer.)																																															
	"Security"	Accesses "Security" screen.																																															
	"Home"	Returns you to the "Home" screen.																																															
	"Back"	Reverts to the last screen viewed.																																															
	"Panic"	Displays Emergency functions (as programmed by the installer). See Programming the Control Panel note. <b>Note:</b> This icon is displayed and active on all screens except while in the Clean Screen mode and during an LCD Display test in Diagnostics.																																															
	"Control Panel Message"	This icon alerts the user to a Control Panel Message.																																															
	"Multi-Media"	Accesses the Message and Picture features.																																															
	"Setup"	Allows access to Setup menus.																																															
	"Voice Status"	Allows user to hear system status.																																															
	"Picture"	Allows user to display personal photos in a slide show format.																																															
	"Minimize Home"	Minimizes the Home screen icons when viewing wallpaper displays.																																															
	"Maximize Home"	Maximizes the Home screen icons when viewing wallpaper displays.																																															
<b>Operating Modes / Language Selection</b>				<b>Notes</b>																																													
<ol style="list-style-type: none"> <li>1. Touch the <b>Disp&amp;Audio Setup</b> icon.</li> <li>2. Enter your "Authorized Code" if required.</li> <li>3. Select <b>Chime Mode</b> or <b>Voice Mode</b> to turn the mode on or off.</li> <li>4. To change the Keypads display language, highlight the button next the desired language. The touchpad will revert back to the "Home" screen with the selected language applied.</li> </ol>		<p>If the Chime Mode and Voice Mode are both selected, the Voice Chime is automatically selected. It may take a few seconds for the Chime Mode to take effect. When the TouchCenter exits the "Operating Modes" screen, your selection is saved. The TouchCenter allows you to select from three languages, (English, French Canadian and Latin American Spanish) with the default being English.</p>																																															
<b>Adjust the Screen Timeouts</b>				<b>Notes</b>																																													
<ol style="list-style-type: none"> <li>1. Touch the <b>Disp&amp;Audio Setup</b> icon.</li> <li>2. Enter your "Authorized Code" if required.</li> <li>3. Touch the desired selection from the drop-down list displaying the time period for each option. <b>Yes</b> saves the change. <b>No</b> discards the change.</li> </ol>		<p>If changes are made, when you exit a <b>Settings Changed!</b> pop-up window is displayed asking <b>"Remember New Settings?"</b></p> <p>Settings include:</p> <ul style="list-style-type: none"> <li>• <b>Backlight Off After X time</b></li> <li>• <b>Return To Homepage After X time</b></li> <li>• <b>Auto Slideshow After X time.</b></li> </ul>																																															
<b>Clean Screen</b>				<b>Notes</b>																																													
<ol style="list-style-type: none"> <li>1. From the "Home" screen, touch the <b>Setup</b> icon.</li> <li>2. Touch the <b>Disp&amp;Audio Setup</b> icon.</li> <li>3. Enter your "Authorized Code" if required.</li> <li>4. Touch the <b>CLEAN SCREEN</b> icon to disable the TouchCenter for 30 seconds so you can wipe the screen clean.</li> </ol> <p>A pop-up window displays <b>"Touch Screen becomes inactive so that you may wipe the screen clean. Please use a damp, soft cloth. DO NOT use any liquids, sprays, or ammonia-based cleaners. Press CONTINUE to disable touchscreen."</b></p> <p><b>** Panics cannot be initiated during this process**</b></p>		<p>At the <b>"Screen Disabled for =30 Seconds"</b> screen, the touch screen should be wiped clean of fingerprints using a mild soap solution and a soft cloth. When the counter reaches zero, the window automatically closes and the touch screen is active.</p> <p><b>IMPORTANT:</b> Do not use an abrasive cleaning agent or abrasive cloth when cleaning the TouchCenter or damage to the touch screen may occur.</p> <p><b>NOTE:</b> The <b>Emergency</b> screen cannot be accessed while running in the clean screen mode.</p> <p>Touch <b>Cancel</b> to exit.</p>																																															
<b>Multi-Media: Picture Setup</b>				<b>Notes</b>																																													
<ol style="list-style-type: none"> <li>1. Insert your personal media (SD/SDHC) card.</li> <li>2. Touch the <b>Multi-Media</b> icon, and then touch the <b>Picture</b> icon.</li> <li>3. Select the type of viewing transition desired by touching the <b>Transition</b> arrow. Select: <b>Standard, Horizontal, Vertical</b> or <b>Fade Out</b>.</li> <li>4. Touch the <b>Slide Delay</b> arrow to select the time interval (5, 10, 15, or 20 seconds) that you want to allow for each photo to be viewed.</li> <li>5. To add an image to the slide show, select the image from the list and press the <b>Add Image</b> icon; the image appears on the screen and a check mark appears next to the selected image name on the list.</li> <li>6. To remove an image from the slide show, select the image, and press the <b>Deselect Image</b> icon.</li> </ol> <p>To set a picture as wallpaper:</p> <ol style="list-style-type: none"> <li>1. Use the slide bar to scroll through the list of pictures and highlight the file you want to be displayed on the keypad screen.</li> <li>2. Touch the <b>Set Wallpaper</b> icon; view your selection from the "Home" screen.</li> </ol> <p><b>NOTE:</b> When viewing wallpaper displays, the Home screen icons can be minimized by touching the "Minimize Home" icon. Touch the "Maximize Home" icon to maximize Home screen icons.</p>		<p>The Picture feature allows you to set up and view up to 1000 photos as a slide show or as your wallpaper display. Photo files can be viewed from the (SD/SDHC) Card. Formats supported are .bmp or .jpg files.</p> <p><b>NOTES:</b></p> <ul style="list-style-type: none"> <li>• To exit the Picture feature at any time and resume keypad operation, touch anywhere on the screen.</li> <li>• The first image is displayed and a list of stored images appears on the screen.</li> <li>• When an image is loading, no other Picture Setup functions can be performed (play, previous, next, add or set wallpaper).</li> </ul> <p>Touch the <b>TOP</b> button to move up one level in the directory.</p> <p>Touch the <b>OPEN</b> button to view larger images and/or open directories, select from the list of stored images.</p> <p>Touch the <b>CLEAR ALL</b> button to clear all pictures from the current slide show rotation. Touch the Picture icon (on the Home screen) to go into the Slide Show feature.</p>																																															
<b>Picture Icons</b>				<b>Panel Default Displays</b>																																													
Play Image		Previous Image		Next Image		Add Image		Minimize Home		Maximize Home																																							
						<p><b>UL</b> Multi-Media functionality is supplementary only and has not been evaluated by UL.</p>		<p>The "Security" screen displays an Icon(s) if a panel fault occurs. The following lists the Icons that are displayed to the left of the Panic icon.</p> <table border="1"> <thead> <tr> <th>ICON</th> <th>MEANING</th> </tr> </thead> <tbody> <tr> <td></td> <td>AC Loss; The system is not receiving AC power.</td> </tr> <tr> <td></td> <td>Bell Failure; The system bell or siren has a problem. <b>Note:</b> This Icon is displayed when interfacing with residential panels only.</td> </tr> <tr> <td></td> <td>Expander Failure; The system has a failure in an expansion module.</td> </tr> <tr> <td></td> <td>Low Battery; The system battery, that powers the system during an AC power loss, is low.</td> </tr> <tr> <td></td> <td>LRR Supervision Failure; The Communication Device used to communicate with the central station has a supervision failure.</td> </tr> <tr> <td></td> <td>Max Attempts Exceeded; The system has exceeded the maximum attempts to communicate with the Central Station.</td> </tr> <tr> <td></td> <td>Pager Failure; The system cannot communicate with an assigned pager.</td> </tr> <tr> <td></td> <td>Telco-1 Cut; The system is not able to communicate with the central monitoring station over the primary phone line.</td> </tr> <tr> <td></td> <td>Telco-2 Cut; The system is not able to communicate with the central monitoring station over the secondary phone line.</td> </tr> <tr> <td></td> <td>Wireless Failure; The system is not able to communicate with its wireless devices.</td> </tr> </tbody> </table>				ICON	MEANING		AC Loss; The system is not receiving AC power.		Bell Failure; The system bell or siren has a problem. <b>Note:</b> This Icon is displayed when interfacing with residential panels only.		Expander Failure; The system has a failure in an expansion module.		Low Battery; The system battery, that powers the system during an AC power loss, is low.		LRR Supervision Failure; The Communication Device used to communicate with the central station has a supervision failure.		Max Attempts Exceeded; The system has exceeded the maximum attempts to communicate with the Central Station.		Pager Failure; The system cannot communicate with an assigned pager.		Telco-1 Cut; The system is not able to communicate with the central monitoring station over the primary phone line.		Telco-2 Cut; The system is not able to communicate with the central monitoring station over the secondary phone line.		Wireless Failure; The system is not able to communicate with its wireless devices.																
ICON	MEANING																																																
	AC Loss; The system is not receiving AC power.																																																
	Bell Failure; The system bell or siren has a problem. <b>Note:</b> This Icon is displayed when interfacing with residential panels only.																																																
	Expander Failure; The system has a failure in an expansion module.																																																
	Low Battery; The system battery, that powers the system during an AC power loss, is low.																																																
	LRR Supervision Failure; The Communication Device used to communicate with the central station has a supervision failure.																																																
	Max Attempts Exceeded; The system has exceeded the maximum attempts to communicate with the Central Station.																																																
	Pager Failure; The system cannot communicate with an assigned pager.																																																
	Telco-1 Cut; The system is not able to communicate with the central monitoring station over the primary phone line.																																																
	Telco-2 Cut; The system is not able to communicate with the central monitoring station over the secondary phone line.																																																
	Wireless Failure; The system is not able to communicate with its wireless devices.																																																

CS Setup		Notes	COMPATIBILITY TABLE		
	1. From the System Setup screen, touch the <b>CS Setup</b> icon.	<p>When the TouchCenter cannot communicate with the alarm panel, the message "ECP Error" is displayed, check the following:</p> <ul style="list-style-type: none"> <li>• Verify that the AUI type device is enabled in the control panel, and that the ECP address in the TouchCenter matches the address enabled in the control panel. Use a different address for each device.</li> <li>• If powering the TouchCenter from a power supply, make sure you have a common ground installed (wiring between Power Supply "gnd" and panel "Aux. power neg").</li> </ul> <p><b>On residential control panels (VISTA-20P or equivalent)</b>, up to four TouchCenters may be used. Addresses 1 and 2 (in field *189) are enabled by default. If the defaults have been changed, enable these addresses (in field *189) using an alpha-keypad and the Data Field Programming procedures located in the panel Installation and Setup Guide.</p> <p><b>On commercial control panels (VISTA-128BP, VISTA-128FBP or equivalent)</b>, These addresses in the control panel are normally not defaulted for AUI type devices. To enable the addresses you are using for TouchCenters, use an alpha-keypad and follow the procedures for "Device Programming" in your control panel "Programming Guide."</p> <p><b>NOTE:</b> When the ECP address is changed, and <b>Apply</b> is selected, the TouchCenter resets.</p>	Alarm System	Maximum Number of TouchCenters	Minimum Software Revision Level
	2. Enter your "Authorized Code", if required. 3. Touch the <b>ECP Address</b> icon.		VISTA-15P, VISTA-20P, FA148CP, FA168CPS	2	3.0
<b>ECP Address</b>			VISTA-20P, FA168CPS	4	5.0
	1. Touch the <b>ECP Address</b> icon. 2. Select the ECP address for this TouchCenter using the Up/Dn arrows. 3. The available ECP addresses are: 1-2, 5-6 for residential controls		* VISTA-21IP	4	1.0
	1-2, 3-30 for commercial controls under Rev. 10 supports 3 AUIs. <b>See Important Note below.</b> 1-30 for commercial controls Rev. 10 and higher supports 6 AUIs. <b>IMPORTANT:</b> If multiple TouchCenters are being used, they must be set to addresses 1, 2, and X (where X equals any address from 3 through 30). Only one AUI type (touch screen) device may be assigned to an address from 3 through 30 on commercial control panels. The TouchCenter should not be assigned as a Master Console. If the TouchCenter is assigned as a Master Console, partitions must be controlled from the Partition screen or using the Console Emulation Mode. <b>Apply</b> accepts the address setting.		VISTA-128BP, VISTA-250BP, VISTA-128BPEN	3	4.4
<b>Lighting/Screen Blackout (EN50131 Display)</b>			VISTA-128FBP, VISTA-250FBP, FA1670C	3	7.0
	1. From the System Setup screen, touch the <b>CS Setup</b> icon. 2. Enter your "Authorized Code", if required. 3. Touch the <b>Options</b> icon.	The Screen Blackout EN50131 Display compliance feature is a European Standard designed to prevent unauthorized users from viewing the status of the Security System. <b>Note:</b> DO NOT select the <b>Automation/Demo Mode</b> option. This option should only be selected if instructed to do so by factory service. When this option is selected, the keypad does not communicate with the control panel and any user can select Advanced Setup screens.	VISTA-128FBPN	3	5.1
	4. Select " <b>Lighting</b> " or " <b>EN50131 Display</b> " to turn the option on or off. 5. Select " <b>Normal Mode</b> " or " <b>Safe Mode</b> " to turn the option on or off. <b>Apply</b> accepts all changes.		VISTA-128BPT, VISTA-250BPT, VISTA-128BPTSIA, FA1660CT	6	10.1
<b>Safe Mode</b>			FA1660C, FA1700C	3	3.0
	1. Select <b>Safe Mode</b> and then touch <b>Apply</b> . 2. Touch the <b>OK</b> icon. 3. To exit, touch the safe mode bar and touch <b>Yes</b> to return to Normal Mode. The TouchCenter resets and restarts in the Safe Mode.		<p>* <b>Not UL Listed.</b> <b>Note:</b> Keypad may only be used in the following UL/cUL installations: UL 365, UL 609, UL 985, UL 1023, UL 1610, CAN/ULC-S303, CAN/ULC-S304, ULC-S545, ULC/ORD-C1023, and ANSO/SIA CP-01-2010. <b>Note:</b> For SIA installations used with VISTA-128BPTSIA Controls, see the SIA CP-01 Quick Reference Chart located on MyWebTech, Document #800-09699.</p>		
<b>Screen Security</b>			<p>When the Screen Blackout (EN50131 Display) feature is enabled:</p> <ul style="list-style-type: none"> <li>• The keypad returns to the "Home" screen after 30 seconds and the "Armed" and "Ready" LEDs turn OFF.</li> <li>• The "To Homepage After" time setting changes to 30 seconds and the time is non-selectable.</li> <li>• The "Auto Slideshow After" is preset to "1" minute and can not be changed.</li> <li>• The Security, Message and Lighting screen does not display system status until an authorized user code is entered.</li> <li>• The "Setup" menu does not display system status until an authorized user code is entered.</li> </ul> <p><b>Operating Modes</b> <b>Automatic Entry-</b> In the rare event that the TouchCenter cannot successfully communicate in its graphic mode with the control panel, the TouchCenter displays "Problems detected. Start Keypad in Safe Mode?" and requests a "Yes" or "No" response. If you answer with "Yes", the TouchCenter enters into the Safe Mode. If you answer with "No", the TouchCenter tries to communicate with the panel again. After 3 consecutive times of receiving no response, the TouchCenter enters the Safe Mode automatically. <b>Manual Entry - Note:</b> ONLY enter the Safe Mode from the Normal Mode. Entering the Safe Mode from the Demo Mode may result in incorrect display of the Emergency Function keys. <b>Operating in the Safe Mode</b> This is a limited mode of operation. While in this mode:</p> <ul style="list-style-type: none"> <li>• You can use the Security icon to access the Console Emulation Mode of operation to try to clear your faults, disarm the system, or enter additional Alpha Keypad commands specified in your panel User and Installation Guides. You can perform almost all functions that you can perform from a standard non-graphic alpha keypad.</li> <li>• You can touch the "Panic" icon and generate Emergency Messages as defined in the panel's home partition for this TouchCenter.</li> <li>• The Armed and Ready LEDs on the front of the TouchCenter indicate the TouchCenter's home partition status.</li> <li>• The Chime mode functions in the Safe Mode; however, there is no Voice, Voice Chime, or Message capability.</li> </ul> <p><b>WARNING:</b> The Slide Show feature does not start automatically in Safe Mode. <b>User Code Setup</b> Each user must be assigned a name with a corresponding 4-digit user code in order to gain access to various features and functions. The TouchCenter can hold the identity for 10 Users in its memory. If additional Users are needed, define the additional Users using the Console Emulation Mode. Users for the system are programmed in a central user setup location that provides the specific questions for authorization levels assigned to different users. You may want these users to be the same, but there are situations in which you may want a user to have limited capabilities. <b>User Related Note</b></p> <ul style="list-style-type: none"> <li>• Users added to the system using the TouchCenter graphic user screen must be deleted from the TouchCenter using the graphic screen as well. Deleting users from the panel by any other means (alpha keypad, console emulation mode, or Compass downloader) does not automatically delete them from the TouchCenter.</li> <li>• If the panel has exit tones enabled and you arm the system in the Away mode, the TouchCenter beeps continuously throughout the exit period.</li> <li>• Use the console emulation mode for the following functions: <ul style="list-style-type: none"> <li>- Programming more than 10 system users.</li> <li>- Programming the Pager report option for users of residential control panels (e.g., VISTA-15P and VISTA-20P).</li> <li>- Special Function Key operations (macros or single-button paging).</li> <li>- End-User Scheduling.</li> </ul> </li> <li>- To check for an "Alarm Cancelled" message if this feature has been enabled in the system.</li> </ul>		
	1. From the System Setup screen, touch the <b>CS Setup</b> icon. 2. Enter your "Authorized Code", if required.	<b>Note:</b> The Screen Security screen contains a heading of Advanced Setup, Central Station Setup, Disp. & Audio Setup, Event Logs, Lighting, Message, Security, and Time/Date.			
	3. Touch the <b>Screen Security</b> icon. 4. If authority levels are correct, touch <b>Back</b> or <b>Home</b> to exit menu. 5. If changes are necessary, select the line to be changed and the level of user to have access, then select the <b>OK</b> icon.	The Screen Security screen is re-displayed listing any changes. <b>Note:</b> The User Levels listed on this screen match the User Levels in commercial panels. See the chart below for corresponding User Levels in Residential Panels.			
<b>Code Authority</b>					
	1. Touch the <b>Code Authority</b> icon. 2. Enter the 4-digit User Code for the user that you want to obtain Authority Level information about. 3. Touch the <b>BACK</b> icon.	The <b>Code Authority</b> icon displays User Names and Partition Authority Level for the User Code.			
<b>Device Events</b>					
	1. Touch the <b>Device Events</b> icon. 2. To view a record of events in a history log, touch the up/down arrow to scroll.	The control panel must be programmed to record various system events in installer programming mode.			
<b>Panel Configuration</b>					
	1. Touch the <b>Panel Config</b> icon. If you select <b>OK</b> , the TouchCenter resets and the panel configuration is downloaded from the panel into the TouchCenter.	A "Panel Configuration" screen is displayed providing details of your system. <b>Delete</b> clears the configuration from the TouchCenter and reloads the panel configuration into the TouchCenter.			
<b>Add/Delete/Edit a User</b>					
	1. From the <b>System Setup</b> screen, touch the <b>User Setup</b> icon. 2. Touch the <b>ADD User</b> icon and enter your "Authorized Code". 3. Touch the box next to <b>Enter User Name</b> ; enter user name. 4. Touch the <b>OK</b> icon. 5. Touch the box next to <b>User Number</b> ; enter User Number for this user. 6. Touch the box next to <b>Enter User Code</b> ; enter the User Code for this user. 7. Touch the box next to <b>RF Button Zone</b> ; enter the 3-digit RF Button Zone for this user. 8. Touch <b>Save</b> . Follow this procedure for deleting and editing users.	<b>Note:</b> The authorized code for adding, deleting and editing users is dependent upon the alarm panel you are connected to. Check your alarm panel Installation and Setup Guide to determine who can add users. Type in the user name (6 characters max.; no spaces between characters) <b>Notes:</b> • Use the <b>Shift</b> key for capital letters. • Use the <b>BS</b> (Backspace) key to make corrections. The <b>@#</b> key is not available for use at this time. If assigning this user to a wireless key, enter one of the zone numbers of the keyfob (the wireless key must be programmed before it can be assigned to a user). <b>NOTE:</b> To edit a User 'name' or 'number', you must delete the User and re-enter.			

Time/Date Setup		Notes																																																						
	<ol style="list-style-type: none"> <li>1. Touch the <b>Time/Date Setup</b> icon; enter your "Authorized Code", if applicable.</li> <li>2. Touch the <b>DST</b> icon to have daylight saving time affect your system clock.</li> </ol>	<p>If <b>DST On</b> (Daylight Saving Time) is selected, the TouchCenter adjusts for Daylight Saving time at the month, week and time chosen.</p>	<p>You can set the time and date from the <b>Set Time &amp; Date</b> screen.</p> <ul style="list-style-type: none"> <li>• When the time is set it is stored in the TouchCenter and sent to the control panel when you touch the <b>Apply</b> icon and answer <b>Yes</b> to the following prompt. Additionally, when using the TouchCenter with a residential panel, the panel downloads its time into the TouchCenter once an hour after the clock is set.</li> <li>• If <b>Get Time</b> is touched, the TouchCenter downloads the time and date from the control panel and exits the <b>Set Time &amp; Date</b> screen.</li> </ul> <p><b>Note:</b> This icon () appears with residential panels only (e.g., VISTA-15P, VISTA-20P).</p>																																																					
	<ol style="list-style-type: none"> <li>3. Set the "Start DST" and then the "End DST" settings by touching the <b>Month, Weekend</b> and <b>Hour</b> that you want DST to start.</li> <li>4. <b>APPLY</b> saves the settings.</li> <li>5. Set the current time by following the prompts and select the current <b>Month, Year, Hour, Minute, AM</b> or <b>PM</b> and <b>Month/Day/Year</b> format.</li> <li>6. Touch <b>Apply</b>.</li> </ol>	<p>Make sure "DST On" is checked to enable this feature.</p> <p>Select <b>YES</b> on the "Time Setting Confirmation" pop-up window to save the changes in your security system. Select <b>No</b> to have the changes affect the TouchCenter only.</p> <p><b>Note:</b> A <b>Yes</b> response is recommended.</p>																																																						
Diagnostic Tests		Notes																																																						
	<ol style="list-style-type: none"> <li>1. From the System Setup screen, touch the <b>Advanced Setup</b> icon.</li> <li>2. Enter your "Authorized Code".</li> <li>3. Touch the <b>Keypad Reset</b> icon; select <b>OK</b>.</li> <li>4. Touch the <b>Keypad Test</b> icon.</li> <li>5. Touch the <b>Test</b> icon associated with the <b>LCD Display Test</b>.</li> </ol> <p>Follow the prompts to complete this test.</p>	<p>If the keypad requires resetting, touch <b>OK</b> and the keypad resets. If <b>Cancel</b> is selected, keypad does not reset.</p> <p>After each type of display, you are asked if the display was proper.</p> <p>If you touch the <b>Yes</b> icon, "Passed" is displayed in the test status column on the "Diagnostics" screen.</p> <p>If you touch the <b>No</b> icon, "Failed" is displayed in the test status column on the "Diagnostics" screen.</p> <p>At the conclusion of the test, a pop-up "Confirmation Window" is displayed with the question "<b>Did you hear Beeping?</b>"</p> <p>At the conclusion of the test, a pop-up "Confirmation Window" is displayed with the question "<b>Did you see chasing LED pattern?</b>"</p>	<p><b>Keypad Test</b></p> <p>A series of diagnostic tests are provided that allow verification of correct operation of the TouchCenter and its connections to the security system. There are a total of four diagnostic tests: <b>LCD Display Test, Audio Test, LED Test</b> and <b>Touch Screen</b> (Calibration).</p> <p><b>Performing Diagnostic Tests</b></p> <p>Select any diagnostic test from the Diagnostics screen by touching its associated <b>Test</b> icon. All or any individual test may be run when you access the Diagnostics screen; however, each test must be performed one at a time.</p> <p>At any time when a test is not being performed, you can touch the back icon to return to the previous screen, or touch the home icon to return to your home page.</p> <p><b>Residential System Notes</b></p> <ul style="list-style-type: none"> <li>• If the Clean Me option is set, when the maintenance signal is received a "Fire Maintenance" message and the Display Faults icon is shown. However, if you display the faults, zone 1 is not shown as a faulted zone.</li> <li>• If RF Jam Reports are selected and RF Jam is detected, the User Authorization screen displays "Trouble ZN100 RF Receiver". If you enter the console emulation mode, the display shows "Check 90 RF Receiver Jam".</li> <li>• Do not use the Custom Word reminder feature.</li> </ul>																																																					
  	<ol style="list-style-type: none"> <li>6. Touch the <b>Test</b> icon associated with the <b>Audio Test</b>; "Testing..." is displayed while beeps sound from the speaker.</li> <li>7. Touch the <b>Test</b> icon associated with the <b>LED Test</b>; "Testing..." is displayed while the 3 LEDs light sequentially, top to bottom (red, green, yellow) 5 times.</li> </ol> <p>If the Touch Screen requires recalibration;</p> <ol style="list-style-type: none"> <li>1. Select the <b>Touch Screen</b> (calibration) icon and using a stylus, follow the screen directions by pressing a series of crosshairs (+) and boxes (□) on the screen until done.</li> <li>2. If the test was successful, press <b>OK</b>. The screen returns to the Keypad Test screen.</li> <li>3. If the test was unsuccessful, choose to <b>Retry, Ignore</b> or <b>Exit</b>.</li> </ol>	<p>If the Calibration test was successful, a confirmation screen appears stating: "<b>Congratulations Calibration Successful!!!</b>"</p> <p><b>If the test was unsuccessful, an error message appears indicating the Part of the screen that failed and stating: "Calibration fail, do you want to retry?"</b></p>																																																						
Night Setup		Notes																																																						
	<ol style="list-style-type: none"> <li>1. Touch the <b>Advanced Setup</b> icon.</li> <li>2. Enter your "Authorized Code", if required.</li> </ol>	<p>The <b>NIGHT</b> icon can be set to arm the system in one of five modes:</p> <ul style="list-style-type: none"> <li>• Away - Arms all zones with entry delay.</li> <li>• Stay - Arms perimeter zones with entry delay.</li> <li>• Instant - Arms perimeter zones without entry delay.</li> <li>• Maximum - Arms all zones without entry delay. Not to be used for ANSI/SIA CP-01 installations.</li> <li>• Night (Residential Panels Only) – Arms all perimeter zones plus all zones listed in Zone List 5.</li> </ul>	<p><b>NIGHT Setup Icon Function</b></p> <p>The TouchCenter is defaulted to arm the system in STAY INSTANT mode when arming the system using the NIGHT icon. You can change the TouchCenter so that it arms the system in a different mode when the NIGHT icon is touched by selecting the arming mode to be activated when the NIGHT icon is touched on the "Arming" screen. Note that some displays on the TouchCenter may not have enough space to display the whole name of a partition. When this occurs, the display shows as many characters as possible starting at the beginning of the partition name. We recommend that the partition name be kept to a maximum of 7 characters to ensure the "H" which indicates the home partition may be seen (this is set at the panel).</p>																																																					
	<ol style="list-style-type: none"> <li>3. Touch the <b>Night Setup</b> icon.</li> <li>4. Select the arming mode to be activated when the <b>NIGHT</b> icon is touched on the "Arming" screen.</li> </ol> <p><b>Apply</b> accepts the setting. <b>Back</b> cancels your selection.</p>																																																							
Output Setup		Notes																																																						
	<ol style="list-style-type: none"> <li>1. From the "Home" screen, touch the <b>System Setup</b> and <b>Advanced Setup</b> icon.</li> <li>2. Enter your "Authorized Code".</li> </ol>	<p>The Output Setup function allows you to disable Output selection. There are a maximum of 18 outputs that can be enabled or disabled.</p>	<p><b>Residential Panels and Screen Security Authority Levels</b></p> <p>Authority levels define the system functions a particular user can perform. Depending on the authority assigned to you, there are certain system functions you may be prohibited from performing. The table below describes the authority levels available in the TouchCenter and provides the equivalent authority level name found in your alarm system manuals.</p> <table border="1"> <thead> <tr> <th rowspan="2">Authority Level in Panel</th> <th rowspan="2">Matching Authority Level in TouchCenter</th> <th colspan="5">Access Level Chosen in TouchCenter Screen Security</th> </tr> <tr> <th>Installer</th> <th>Master</th> <th>Manager</th> <th>Operator A</th> <th>Operator B</th> <th>Operator C</th> </tr> </thead> <tbody> <tr> <td>System Master</td> <td>Master</td> <td>No</td> <td>Yes</td> <td>Yes</td> <td>Yes</td> <td>Yes</td> <td>Yes</td> </tr> <tr> <td>Partition Master</td> <td>Master</td> <td>No</td> <td>Yes</td> <td>Yes</td> <td>Yes</td> <td>Yes</td> <td>Yes</td> </tr> <tr> <td>Standard User</td> <td>Normal</td> <td>No</td> <td>No</td> <td>No</td> <td>Yes</td> <td>Yes</td> <td>Yes</td> </tr> <tr> <td>Arm Only</td> <td>N/A</td> <td>No</td> <td>No</td> <td>No</td> <td>No</td> <td>No</td> <td>No</td> </tr> <tr> <td>Guest</td> <td>Guest</td> <td>No</td> <td>No</td> <td>No</td> <td>No</td> <td>Yes</td> <td>Yes</td> </tr> </tbody> </table>	Authority Level in Panel	Matching Authority Level in TouchCenter	Access Level Chosen in TouchCenter Screen Security					Installer	Master	Manager	Operator A	Operator B	Operator C	System Master	Master	No	Yes	Yes	Yes	Yes	Yes	Partition Master	Master	No	Yes	Yes	Yes	Yes	Yes	Standard User	Normal	No	No	No	Yes	Yes	Yes	Arm Only	N/A	No	No	No	No	No	No	Guest	Guest	No	No	No	No	Yes	Yes
Authority Level in Panel	Matching Authority Level in TouchCenter	Access Level Chosen in TouchCenter Screen Security																																																						
		Installer	Master	Manager	Operator A	Operator B	Operator C																																																	
System Master	Master	No	Yes	Yes	Yes	Yes	Yes																																																	
Partition Master	Master	No	Yes	Yes	Yes	Yes	Yes																																																	
Standard User	Normal	No	No	No	Yes	Yes	Yes																																																	
Arm Only	N/A	No	No	No	No	No	No																																																	
Guest	Guest	No	No	No	No	Yes	Yes																																																	
 	<ol style="list-style-type: none"> <li>3. Touch the <b>Output Setup</b> icon.</li> <li>4. Touch the <b>Output Disable</b> icon to disable the selection.</li> <li>5. Touch the <b>Output Enable</b> icon to enable the Output selection.</li> </ol> <p><b>Apply</b> accepts the setting. <b>Back</b> cancels your selection.</p>	<p><b>NOTE:</b> These are local settings for the graphic keypad. If user has the maximum number of keypads on the system, and wants to disable the same output for all, each keypad needs to be set individually.</p>																																																						
<p><b>Commercial System Notes</b></p> <ul style="list-style-type: none"> <li>• If the Aux Relay function is set for alarm silenced by User Code + # + 67, this command may only be entered in the console emulation mode.</li> <li>• Do not use the common lobby logic function.</li> <li>• If fields 2*22 (Display Fire Alarms of other Partitions), 2*23 (Display Burg &amp; Panic of other Partitions), or 2*24 (Display Troubles of other Partitions) are enabled, the zones that created the conditions cannot be viewed. You must go to that zone's home partition to view.</li> <li>• If field 1*11 (Zone Bypass After Disarm) is enabled, you must use the TouchCenter's Console Emulation Mode and the commands "Code" + "64" (unbypass all) or "Code" + "6" + "Zone Number" (unbypass zone) to remove zone bypasses.</li> <li>• The First to Alarm Display Lock feature (field 1*10) is not supported by the TouchCenter.</li> <li>• RF Low Battery messages are not supported by the TouchCenter except in the Show Zones screen where a Battery Icon is displayed for the zone with the low battery.</li> </ul> <p><b>General Notes</b></p> <ul style="list-style-type: none"> <li>• "Exit Error" and "Auto Arm Alert, Please Leave Now" messages are not displayed by the TouchCenter.</li> <li>• When the system has 6150Vs or 6160Vs, and 6271Vs attached, the Additional Console setting in the 6150Vs (displayed as A on the 6150V) must be set to 1 and the Additional Console setting in the 6160Vs must be set to Yes.</li> </ul>		<p><b>FEDERAL COMMUNICATIONS COMMISSION STATEMENTS</b></p> <p>The user shall not make any changes or modifications to the equipment unless authorized by the Installation Instructions or User's Manual. Unauthorized changes or modifications could void the user's authority to operate the equipment.</p> <p><b>FCC CLASS B STATEMENT</b></p> <p>This equipment has been tested to FCC requirements and has been found acceptable for use. The FCC requires the following statement for your information: This equipment generates and uses radio frequency energy and if not installed and used properly, that is, in strict accordance with the manufacturer's instructions, may cause interference to radio and television reception. It has been type tested and found to comply with the limits for a Class B computing device in accordance with the specifications in Part 15 of FCC Rules, which are designed to provide reasonable protection against such interference in a residential installation. However, there is no guarantee that interference will not occur in a particular installation. If this equipment does cause interference to radio or television reception, which can be determined by turning the equipment off and on, the user is encouraged to try to correct the interference by one or more of the following measures:</p> <ul style="list-style-type: none"> <li>• If using an indoor antenna, have a quality outdoor antenna installed.</li> <li>• Reorient the receiving antenna until interference is reduced or eliminated.</li> <li>• Move the radio or television receiver away from the receiver/control.</li> <li>• Move the antenna leads away from any wire runs to the receiver/control.</li> <li>• Plug the receiver/control into a different outlet so that it and the radio or television receiver are on different branch circuits.</li> <li>• Consult the dealer or an experienced radio/TV technician for help.</li> </ul> <p><b>INDUSTRY CANADA CLASS B STATEMENT</b></p> <p>This Class B digital apparatus complies with Canadian ICES-003.</p> <p>Cet appareil numérique de la classe B est conforme à la norme NMB-003 du Canada.</p> <p><b>FCC / IC STATEMENT</b></p> <p>This device complies with Part 15 of the FCC Rules, and RSS 210 of IC. Operation is subject to the following two conditions: (1) This device may not cause harmful interference (2) This device must accept any interference received, including interference that may cause undesired operation.</p> <p>Cet appareil est conforme à la partie 15 des règles de la FCC &amp; de RSS 210 des Industries Canada. Son fonctionnement est soumis aux conditions suivantes: (1) Cet appareil ne doit pas causer d'interférences nuisibles. (2) Cet appareil doit accepter toute interférence reçue y compris les interférences causant une réception indésirable.</p>																																																						
	CO annunciation has not been investigated by UL and may not be used for UL installations.																																																							
*For additional troubleshooting procedures, refer to the Control Panel Installation Guide.																																																								
<b>WARRANTY</b> For the latest warranty information go to: <a href="http://www.security.honeywell.com/hsc/resources/wa/">http://www.security.honeywell.com/hsc/resources/wa/</a>																																																								
 <b>2 Corporate Center Drive, Suite 100</b> <b>P.O. Box 9040, Melville, NY 11747</b> Copyright © 2013 Honeywell International Inc. <a href="http://www.honeywell.com/security">http://www.honeywell.com/security</a>																																																								
			<b>800-07600V3 4/13 Rev. C</b>																																																					